

**BAYT 980**  
Oil-hydraulic

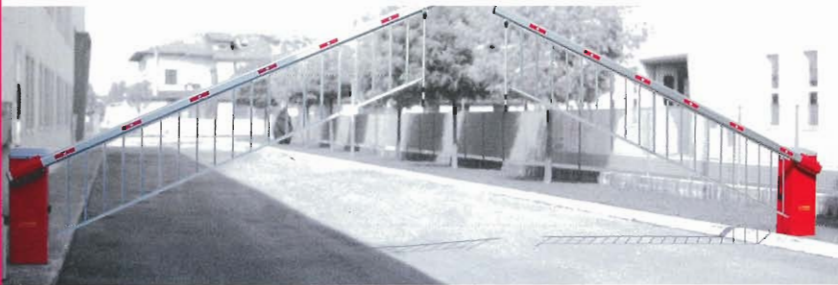

# BAYT 980

## Oil-hydraulic Road Traffic Barrier

BAYT 980 painted version

BAYT 980 stainless steel version inox

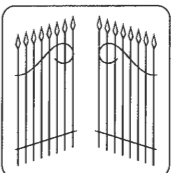

**FADINI**<sup>®</sup>  
the gate opener  
Made in Italy

GB

## Oil-hydraulic road traffic barrier

# BAYT 980

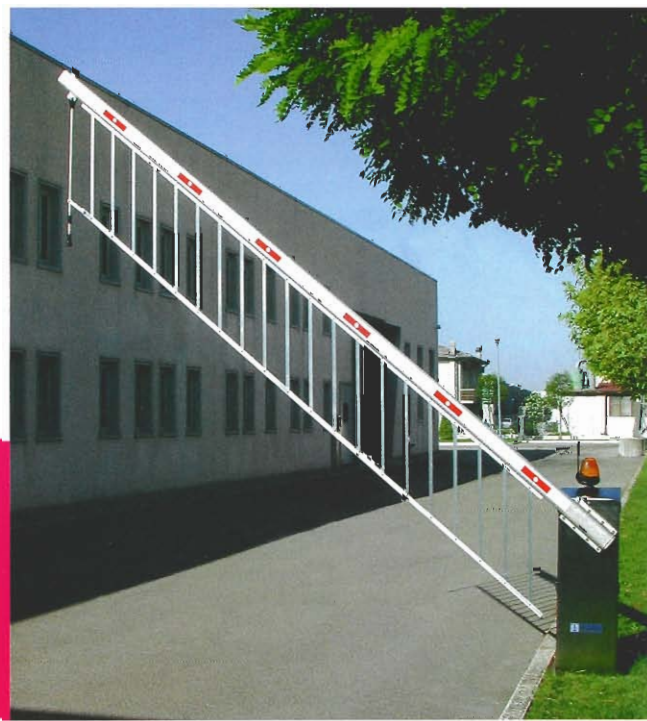

**Stainless steel inox** version with fence and Miri 4 flashing light.

The **Bayt 980** operator is a road barrier used to prevent and completely restrict the full width of any driveway or road access.

### Designed for continuous use

The **Bayt 980** road barrier features innovative components and is designed for use in circumstances requiring **heavy duty performance**, guaranteeing a reliability quality standard that represents the operator's distinguishing feature.

### A single compact body

The product's structure includes a painted, treated steel plate support post, with a shaped, reinforced interior housing the electronic management programmer and the motor-main unit –hydraulic piston - compression spring unit. This unit is assembled as a **single compact body**, making the **Bayt 980** practical and reliable, **without loose components** requiring difficult installation and maintenance operations.

### New arm section

With its elliptical section, the entire length of the anodised aluminium arm is devoid of dangerous edges, to guarantee total safety.

The section also includes a lower runner for the optional installation of aluminium fences (barrier attached below the arm) or rubber safety strips.

The arm is provided in two separate lengths (3.20 and 2.10 metres), for connection with an inner expansion joint that makes it possible to cover any carriageway width.

In order to make the barrier visible at night, the following accessories are available:

- as standard issue, red **reflective adhesive strips** to be applied on the arm
- as an optional, **flashing red LEDs**, to be fitted to the entire length of the arm (request upon ordering).

The moving arm has a fixed fork-shaped or folding pedestal.

The barrier action is guaranteed by the rotation of the arm.

Articulated arms are available subject to specific request for access to covered areas and underground garages.

A hinge-mounted painted and treated steel sheet door grants access to the components inside when using a master card. A voltage cut out switch is supplied as standard issue in order to interrupt the power supply to the programmer inside when the door is opened.

A treated and painted aluminium cover covers the top of the support post housing the limit switches and designed for the installation of the Miri 4 flashing light. Installation requires prior cement embedding of the anchorage base with brackets screwed in and protruding for the subsequent clamping to the **Bayt 980** operator.

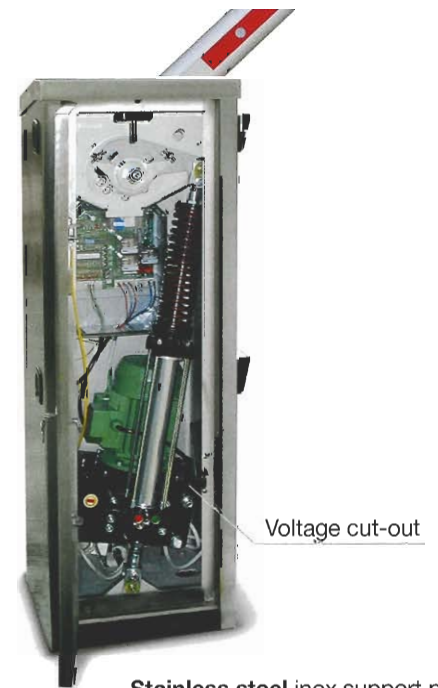

**Stainless steel inox** support post

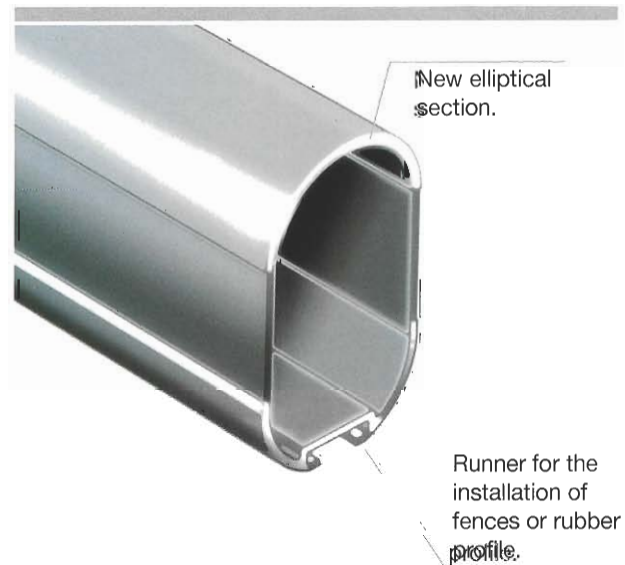



## Smooth, silent operation

The hydraulic operation of the arm is as silent as it is seamless, with deceleration approaching closure (variable interval) and opening when the arm is vertical (fixed deceleration). The force developed by the piston can be adjusted using the maximum hydraulic pressure regulators during opening and closure. A compression spring facilitates arm ascent operations even in manual release situations consequent to blackouts.

The **Bayt 980** is provided:

- complete with installation and maintenance instructions
- calibrated and tested to suit the specific application
- right- or left-handed operation
- two-colour paint or AISI 304 stainless steel inox version (contains stainless steel internal structural and operative components).

Each individual **Bayt 980** component is developed, checked and tested in the Meccanica Fadini factories to guarantee the product's quality and professional standard.



Two-colour painted version of Bayt 980 with fence and Polo 44 photoelectric cells.

Bayt 980 right-hand version with Visual 344 modular accessory post

Bayt 980 with Polo 44 photoelectric cells on support post and Geco 9 token-operated control device.

### Standard issue colours

Ral 2002 orange red and metallic grey

Stainless steel inox

*A surcharge will be applied for RAL colour orders differing from standard issue colours.*

Standard production		Opening times
4,20 metre arm	-	4 seconds
6,40 metre arm	-	8 seconds
6,40 metre arm	with fence	14 seconds
8,50 metre arm	with fence	19 seconds

### Each BAYT 980 code article includes:

Cabinet pedestal with master-key commanded opening door and aluminium cover with closure plugs and holes for Polo 44 installation and Prit 19

Main-unit-Piston-Compression spring unit for 90° arm raising, type "COS 982"

ELPRO 10 PLUS series electronic programmer

Electric system connected to arm limit switch, electric motor, circuit breaker

Circuit breakers with forced interruption and earthed power cable

R532 aluminium arm connection with 8 bolts.

Fixing plate with galvanised log bolts and M14 clamping nuts

Standard issue two-colour version Ral 2002 orange red and metallic grey

Without arm and folding or fork-shaped support post

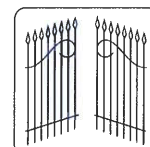

**BAYT 980**  
Oil-hydraulic



Electric motor  
Oil-hydraulic main unit



Closed stainless steel support post with lock and MIRI 4 flashing light.  
**Stainless steel inox** right-hand version



Operation connector with 8 clamping screws suitable for R532 aluminium profile.

Standard issue indicator light  
Bayt 980 electrically powered



Painted support post with MIRI 4 flashing light, with 40 kg counterweight and fence applied to arm.



Fixed fork-shaped pedestal, also available in **stainless steel inox** version.

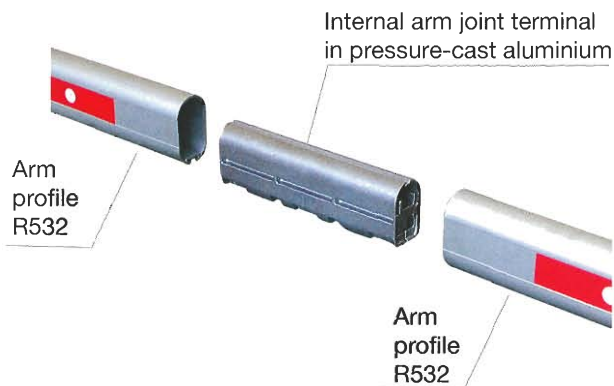

Arm profile R532

Internal arm joint terminal in pressure-cast aluminium

Arm profile R532

Fastening terminal for joining two pieces of R532 arm.

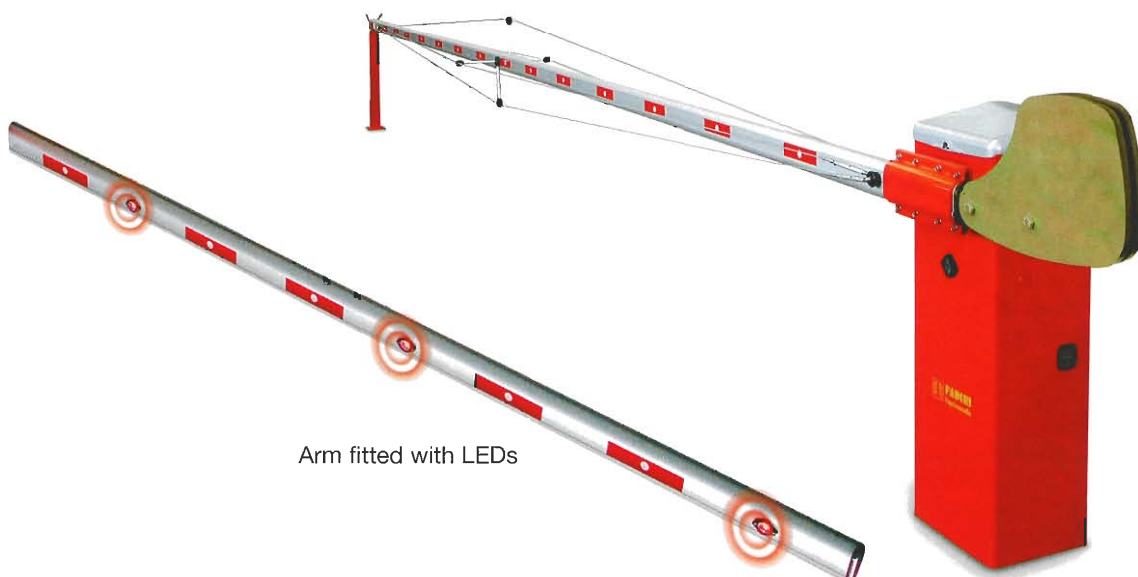

Arm fitted with LEDs

8.0 metre right-handed Bayt 980 with reinforcement ropes, counterweights and painted support post. Also available in **stainless steel inox** version.

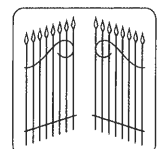

**FADINI**  
the gate opener  
Made in Italy

# BAYT 980

Oil-hydraulic

Optional LEDs applied on arm in holes provided

Opening key

Aluminium removable cover painted, metallic grey version

Plaque specifying Bayt 980 type and model



Adjustable limit switch with spring-loader feeler

Designed to house Prit 19 key switch

Interchangeable right- and left-handed connecting rod

Electronic programmer

Support post with R532 arm applied and designed for photoelectric cells with two holes on either side Polo 44 and Prit 19 key switch

Designed for Polo 44 photoelectric cell installation

Operation piston

Forced voltage cut-out

Earthed steel door with lock Metallic grey paint

Painted (RAL 2002) steel support post with electronic programmer, operation connection rod, spring-loaded piston, oil hydraulic main unit and electric motor.

R532 aluminium arm with reflective adhesive strips, provided in modules to be joined together with a dedicated joining terminal. Subject to request the arm is provided with LEDs. Arm length is established upon ordering

Folding support with adjustable foot





# BAYT 980 Oil-hydraulic road traffic barrier

## BAYT 980 Oil-hydraulic



Electric motor	
Output	0,37KW (0,5HP)
Power supply voltage	230V
Frequency	50Hz
Absorbed current	2.4A
Consumption power	510 W
Capacitor	20 µF
Motor turning speed	1'350 rev./1'
Intermittent service	S3

Oil-hydraulic main unit	
Mean operating pressure	2MPa (20bars)
Maximum pressure dispensed	4MPa (40bars)
Hydraulic oil	Oil Fadini A 15 by Agip
Tank volume	2.5 litres
Static weight of the Main Unit-Piston unit	22.5 Kg
Operating temperature	-20°C +80°C
Protection Class	IP 673

Other Features	
Weight of complete Bayt 980 support post	75 Kg
Support post colour	RAL 2002 orange red
Colour of cover and door	metallic grey

*A surcharge will be applied for RAL colour orders differing from standard issue colours.*

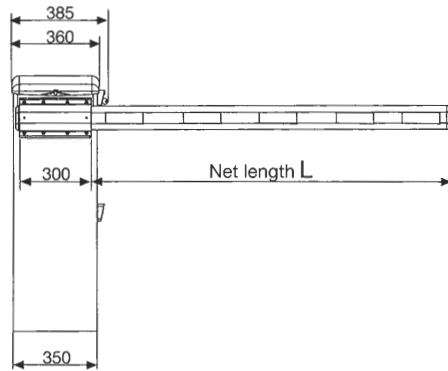

View with R532 arm connection on left-handed Bayt 980

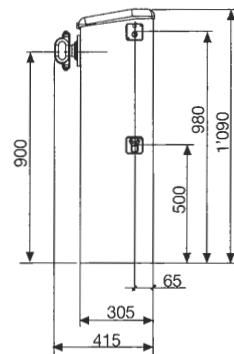

Lateral view photoelectric cell side

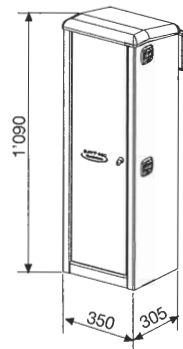

Lateral view two-coloured door

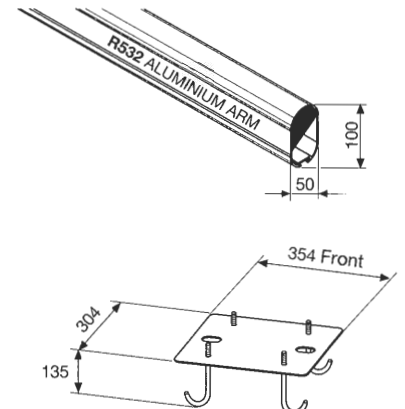

Anchor plate 354x304 with M14x200 log bolts



We recommend that installation complies with applicable regulations, the instructions enclosed and EN 12453 and EN 12445 standards in observance of essential EC requisites



Directive 2003/108/EC  
Disposal of electric and electronic material  
**DO NOT DISPOSE OF AS NORMAL WASTE  
HARMFUL TO THE ENVIRONMENT**



AUTOMATIC GATE MANUFACTURERS

Via Mantova, 177/A - 37053 Cerea (Verona) Italy  
Tel. +39 0442 330422 r.a. - Fax +39 0442 331054  
e-mail: info@fadini.net - www.fadini.net

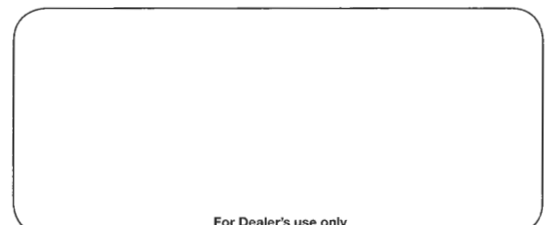

For Dealer's use only

The Manufacturer reserves the right to make changes to the product without giving notice